

6320 SureSense™ Capacitance Propane Level Sensor

BLE output sensor and capacitance probe for use with high pressure propane tanks



The 6320 SureSense™ Capacitance level sensor measures liquid level in a propane tank without relying on a mechanical system. The capacitive technology used in the 6320 removes any moving parts inside the tank eliminating interference between the sensor, tank wall, and other components. The replaceable electronics module is battery powered and provides a periodic BLE broadcast output and a visual digital readout. These options not only allow users to read the tank level in person but enable telemetry units to connect and monitor the level as well. The device conforms to typical IECEx/ATEX/UKEX/CSA safety requirements for use in Class 1 Division 1 (Zone 0) hazardous locations.

The electronics module is designed to support a 10-year battery life and can be replaced at the end of its service interval. The probe inside the tank is permanently mounted and left in place when the electronics module is replaced. The electronics module is not user serviceable.

A local LCD shows the current tank level in percentage on a large, easy-to-read display. The LCD is always on and is automatically updated anytime the sensor reads a new level. Sensor status information is displayed on the LCD as well as level to assist the user in maintaining their propane level.

Wireless operation simplifies installation and eliminates common issues with cable connection and cable damage. A broadcast occurs every 2.2 seconds so telemetry units can scan at any time and get the latest level and sensor status. The broadcast status will indicate additional information such as errors and low or high warnings. Estimated battery life is included in the broadcast and can be used to create an estimated battery percentage. The Rochester 6320 supports OTA (Over the air) firmware updates via the Bluetooth interface.

Application

The Rochester 6320 SureSense™ Capacitance Propane Level Sensor is a versatile sensing unit with no moving parts. A new level reading is acquired every 15 seconds and will update the LCD and BLE broadcast on the fly. The 6320 SureSense™ incorporates a fill detect mode. When a fill is detected, the 6320 sensor will acquire new level readings every second and update the LCD. The 6320 will automatically exit fill detect mode.

The capacitive sensing element is permanently installed into the tank and the calibration data for the unit is stored inside it. Replacing the electronics is simple and can be performed when the battery is consumed without the user needing to perform any set up or calibration to use the system.

- Wide Temperature Range: -40°C to +80°C
- Probe Assembly
 - No moving parts
 - Excellent accuracy especially at low tank levels
 - Mechanically robust, designed for the rigors of transporting and setting tanks & cylinders.
 - Sensor mounting options include 4-bolt and various NPTF adapter sizes.
 - Patented probe seal – designed to prevent content leakage under extreme conditions.



E. & O.E. ©Rochester Sensors.

Since the suitability of these products depends upon a wide range of factors not in our control, Rochester Sensors expects and understands that you conduct the testing and evaluation necessary to determine that these products are suitable for your application. While every effort is made to ensure the above details are correct at the time of printing, Rochester Sensors reserves the right to make material changes, and or technical changes without notification.

General Information and Features







- Polycarbonate housing offers excellent mechanical properties, UV, and chemical resistance.
- No exposed sensing elements, all components are located on the PCB inside the housing.
- Housing: IK9 impact rating
- Ingress Protection: IP69K9 rated.

Key Benefits

- BLE broadcast for simple and robust communications
- Fast installation time
- Easy to read digital display shows tank volume in 1% increments.
- Rugged plastic housing
- 1" NPTF threaded connection to tank standard. Contact your local Rochester Sensors sales team for additional mounting options.

LCD Status Indicators

The 6320 sensor is equipped with a 2-digit 7-segment LCD display. The LCD will show the level in 1% increments with time-multiplexed status codes to indicate different sensor conditions. Some status codes are considered errors while some are considered warnings. Refer to each code for an expected system behavior. Refer to Appendix A for all system errors and warnings.

LCD OUTPUT	DESCRIPTION
	nC: Electronics are not connected to probe. The level will be set to 0% and alternate with this code. Typically, will be seen when a replacement unit is shipped without a probe attached, but may indicate a physical issue has developed on a previously working system.
	bL: Battery Low. Battery is estimated to be within 1-2 years of expected end of life. The measured level will alternate on the LCD with this code.
	bC: Battery Critical. Battery is estimated to be < 1 year of expected end of life. The measured level will alternate on the LCD with this code.
	Er: Device Error. Device is not functioning correctly, and electronics should be replaced. The level will be set to 0% and alternate with this code.
	Lo: Low Low Warning. Tank level is below sensor operating range. This is the typical value for a newly installed probe in a tank that has not been filled.
	Hi: High High Warning. Tank level is above sensor operating range.

Effect of Temperature on Measurements

Changes in ambient temperature cause a corresponding change in density of propane. This change will manifest as an error in reported tank value. The relative change in density and the change in dielectric constant act in opposite directions causing much of the temperature change to be automatically compensated out when compared to a traditional float gauge. Figure 3 shows a chart showing the difference in reported level from actual level. The horizontal axis is the actual level in the tank from 0 to 80% and the vertical axis shows the error in the reported value as a percentage of tank level. The reference temperature for the plot is 25°C and varying temperatures from -40°C to 80°C are plotted.

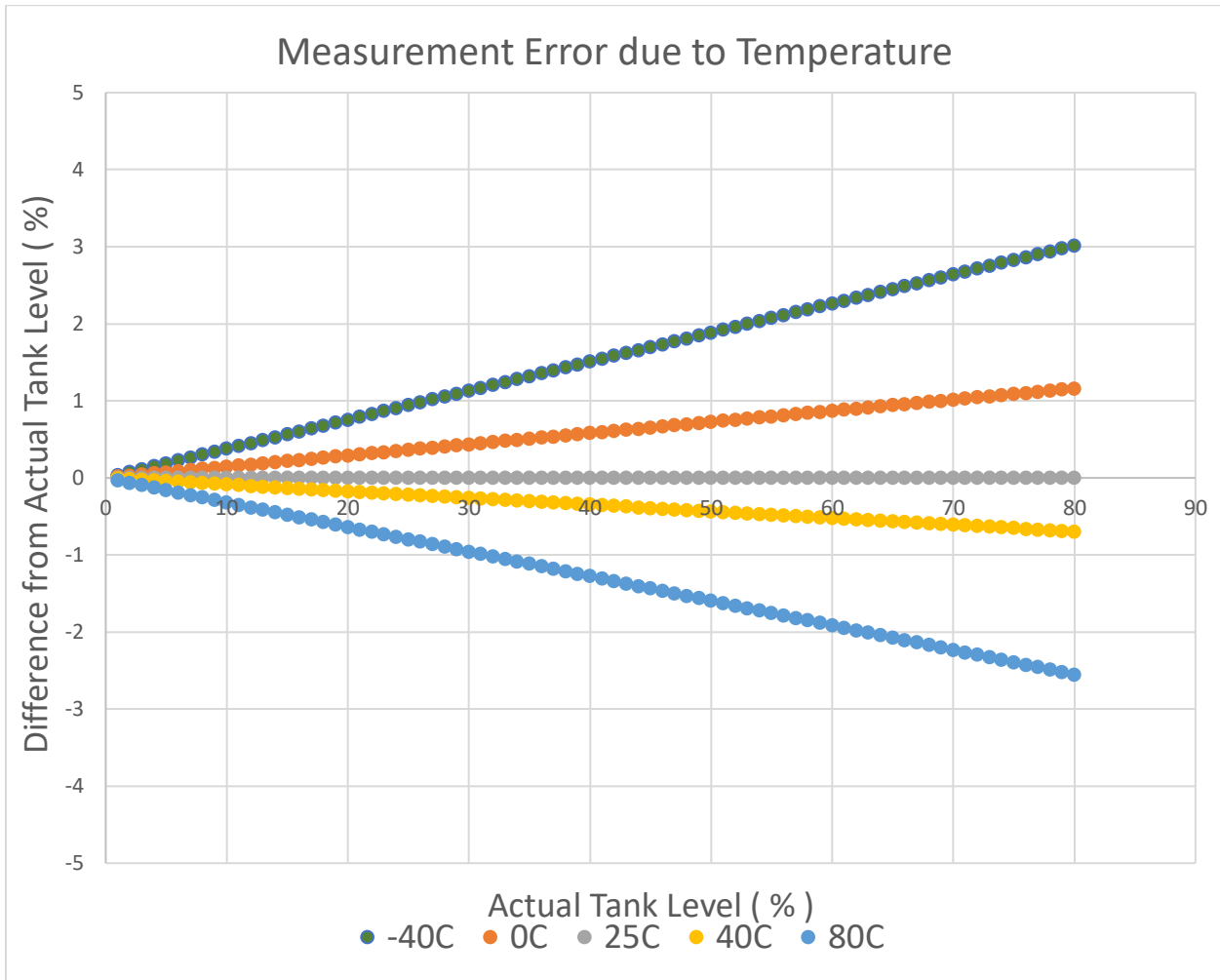

Figure 3. Temperature effect on measurement

Effect of Propane Blend on Measurements

Changes in the blend of propane and butane cause a corresponding change in the density and dielectric constant of the resulting fluid. This change will manifest as an error in reported tank value. Figure 4 shows the resulting error with 3 different propane/butane blends: 0% butane, 5% butane and 10% butane. The actual tank level is shown on the horizontal axis and the error from actual level is shown on the vertical axis.

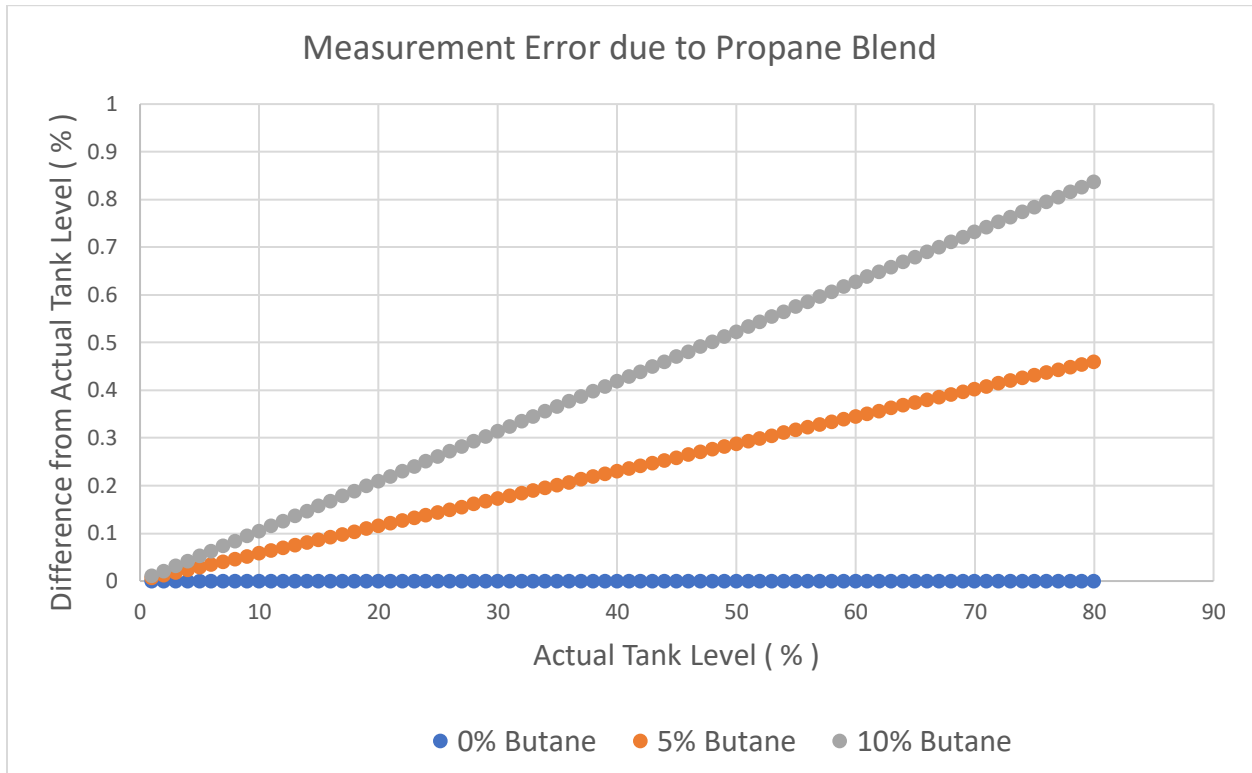

Figure 4. Propane Blend effect on measurement

Broadcast protocol

PACKET TYPE 0x0101 TELEMETRIC PACKET 2.2sec INTERVAL		
Bytes	Payload Contents	Description
0	Flag 0	BLE Protocol Specified
1	Flag 1	BLE Protocol Specified
2	Flag 2	BLE Protocol Specified
3	Length	0x14
4	Type Flag (0xFF)	Manufacturer Specific Data
5	MM – Byte 0 ³	0x7F – RS ID from bluetooth.com
6	MM – Byte 1 ³	0x0C – RS ID from bluetooth.com
7	Byte 1 RS device name	0x52 – ASCII “R”
8	Byte 2 RS device name	0x4F – ASCII “O”
9	Byte 3 RS device name	0x53 – ASCII “S”
10	Byte 4 RS device name	0x63
11	Byte 5 RS device name	0x20
12	0x01 (identification of content type)	LSB
13	0x01 (identification of content type)	MSB
14	Status ¹	See status table
15	RAW DATA TYPE	0x00 = %
16	RAW DATA LSB ²	
17	RAW DATA MSB ²	
18	Reserved	
19	Battery LSB	(uint16) Battery Raw = (uint16)(Battery MSB Battery LSB)
20	Battery MSB	Battery Raw/(0xFFFF) = (uint16)(% Battery Remaining)
21	Reserved	
22	Reserved	
23	Version	0x0A – 0x0F

Note 1: See Appendix for status values.

Note 2: Possible values 0x01E – 0x3CA (3%-97%) in 0.1% per bit increments.

Note 3: Little Endian format per the Bluetooth spec Core_v5.4 Chapter 2.9 “Type Names”. Bluetooth.com company code is 0x0C7F.

Product Certification

Rochester Sensors 6320 units are certified as intrinsically safe for Class 1, Division 1, Groups C & D (Zone 0) hazardous locations. Products are marked and approved by ETL, ATEX, UKCA, and CE. Certification and testing have been performed to the following standards:

Ordinary Locations Safety Standards	
Conforms to UL STD 61010-1 Ed.3	Electrical Equipment for Measurement, Control, and Laboratory Use; Part1: General Requirements *Note: for USA ordinary locations listing certification
Certified to CSA STD C22.2 #61010-1-12 Ed.3	Electrical Equipment for Measurement, Control, and Laboratory Use; Part1: General Requirements *Note: for Canada ordinary locations listing certification
UL 565 Revision 6	Pending
EN 13799:2022	Pending
Hazardous Locations Safety Standards	
IEC 60079-0: 2017	Explosive atmospheres – Part 0: Equipment – General requirements *Note: For IECEx Certification
EN 60079-0: 2011 + C1: 2012	Explosive atmospheres – Part 11: Equipment protection by intrinsic safety “i” *Note: For IECEx Certification
EN 60079-0: 2018	Explosive atmospheres – Part 0: Equipment – General requirements *Note: For ATEX Certification
EN 60079-0: 2012	Explosive atmospheres – Part 11: Equipment protection by intrinsic safety “i” *Note: For ATEX Certification
UL 60079-11, 6th Ed., Issued 03/26/2019	Explosive atmospheres – Part 0: Equipment – General requirements *Note: For USA listing Certification
UL 60079-11, 6th Ed., Revised 03/28/2014	Explosive atmospheres – Part 11: Equipment protection by intrinsic safety “i” *Note: For USA listing Certification
CSA C22.2 No. 60079-0: 2011	Explosive atmospheres – Part 0: Equipment – General requirements *Note: For Canada listing Certification
CSA C22.2 No. 6009-11: 2011	Explosive atmospheres – Part 11: Equipment protection by intrinsic safety “i” *Note: For Canada listing Certification

Environmental Ratings

E. & O.E. ©Rochester Sensors.

Since the suitability of these products depends upon a wider range of factors not in our control, Rochester Sensors expects and understands that you conduct the testing and evaluation necessary to determine that these products are suitable for your application. While every effort is made to ensure the above details are correct at the time of printing, Rochester Sensors reserves the right to make material changes, and or technical changes without notification.

Parameter	Condition	Min	Typical	Max	Unit
Operating & Storage Temperature Range	Temperature Range	-40	-	80	°C
Module Accuracy		-	<1%	-	Level

Environmental Testing

Test	Condition
UV withstand	600 hrs, UVA-340 @.76W/m2, 70°C
VIBRATION	Mil STD-810: 5 Hz, 12.7mm amplitude, 1G, 45 minutes

Dimensions

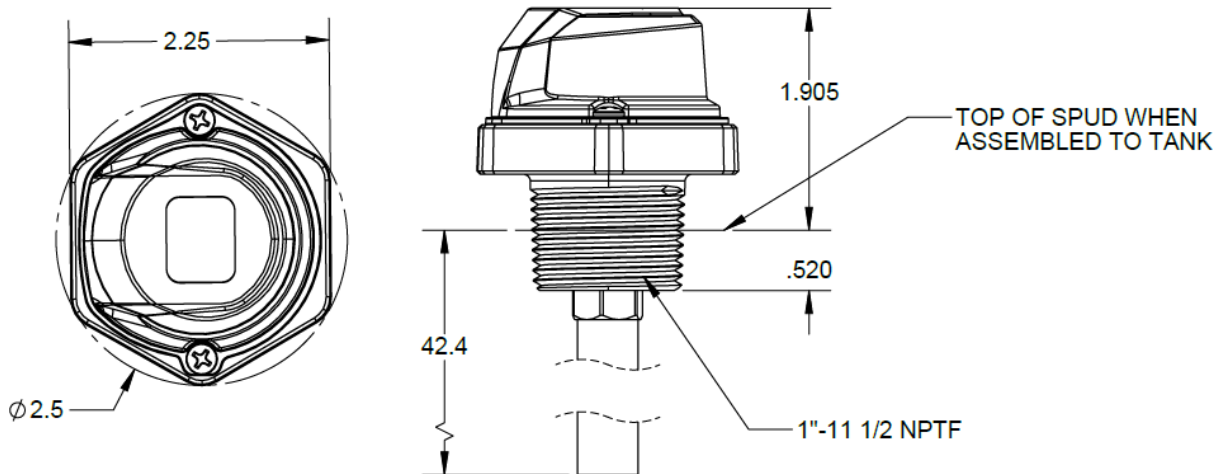

All units in Inches

E. & O.E. ©Rochester Sensors.

Since the suitability of these products depends upon a wider range of factors not in our control, Rochester Sensors expects and understands that you conduct the testing and evaluation necessary to determine that these products are suitable for your application. While every effort is made to ensure the above details are correct at the time of printing, Rochester Sensors reserves the right to make material changes, and or technical changes without notification.

Part Numbers

- 6320-01001 420 lb. Vertical Tank
- 6320-01002 Horizontal tanks
- 6320-01001-EU 420 lb. Vertical Tank with European Union level indications
- 6320-01002-EU Horizontal tanks with European Union level indications

Ordering Information

Contact your local sales representative for samples, availability, and pricing information.

Installation

See Document DS-02043

FCC Interference statement (Part 15.19)(a)(3)

This device complies with part 15 of the FCC Rules. Operation is subject to the following two conditions: (1) This device may not cause harmful interference, and (2) this device must accept any interference received, including interference that may cause undesired operation.

FCC Interference Statement — PART 15.105 (B)

Note:

This equipment has been tested and found to comply with the limits for a Class B digital device, pursuant to part 15 of the FCC Rules. These limits are designed to provide reasonable protection against harmful interference in a residential installation. This equipment generates, uses, and can radiate radio frequency energy and, if not installed and used in accordance with the instructions, may cause harmful interference to radio communications. However, there is no guarantee that interference will not occur in a particular installation. If this equipment does cause harmful interference to radio or television reception, which can be determined by turning the equipment off and on, the user is encouraged to try to correct the interference by one or more of the following measures:

- Reorient or relocate the receiving antenna.
- Increase the separation between the equipment and receiver.
- Connect the equipment into an outlet on a circuit different from that to which the receiver is connected.
- Consult the dealer or an experienced radio/TV technician for help.

ISED Canada compliance statement

This device complies with ISED Canada licence-exempt RSS standard(s). Operation is subject to the following two conditions: (1) this device may not cause interference, and (2) this device must accept any interference, including interference that may cause undesired operation of the device.

Le présent appareil est conforme aux CNR d'ISED Canada applicables aux appareils radio exempts de licence. L'exploitation est autorisée aux deux conditions suivantes : (1) l'appareil ne doit pas produire de brouillage, et (2) l'appareil doit accepter tout brouillage radioélectrique subi, même si le brouillage est susceptible d'en compromettre le fonctionnement.

Appendix A

System Conditions	BLE STATUS BYTE	BLE BROADCAST LEVEL	LCD OUTPUT	Description
Normal	0x0	Level	Level	Normal Operation
Device Error	0x1	0	88 /00	Er: Device error. Device is not functioning correctly and electronics should be replaced. The level will be set to 0% and alternate with this code.
Tank Level < 5%	0x2	Level	88	Measurement Low Low Warning <ul style="list-style-type: none"> LCD displays static "Lo" Typical value for new tanks before initial propane fill
Tank Level < 10%**	0x6	Level	88 /Level	Measurement Low Warning <ul style="list-style-type: none"> LCD displays alternating "Lo" and level
Tank Level > 85%	0x7	Level	88 /Level	Measurement High Warning <ul style="list-style-type: none"> LCD displays alternating "HI" and level
Tank Level > 95%	0x3	Level	88	Measurement High High Warning <ul style="list-style-type: none"> LCD displays static "HI"
NOT CONNECTED	0x4	0	88 /00	nC: Electronics are not connected to probe. The level will be set to 0% and alternate with this code.
Battery Low	-	Level	88 /Level	bL: Battery low. Battery is estimated to be within 1-2 years of expected end of life. The measured level will alternate on the LCD with this code plus any level warning codes (if any).
Battery Critical	-	Level	88 /Level	bC: Battery critical. Battery is estimated to be < 1 year of expected end of life. The measured level will alternate on the LCD with this code plus any level warning codes (if any)

** For EU products the LO warning level is 20%

E. & O.E. ©Rochester Sensors.

Since the suitability of these products depends upon a wide range of factors not in our control, Rochester Sensors expects and understands that you conduct the testing and evaluation necessary to determine that these products are suitable for your application. While every effort is made to ensure the above details are correct at the time of printing, Rochester Sensors reserves the right to make material changes, and/or technical changes without notification.