

a)

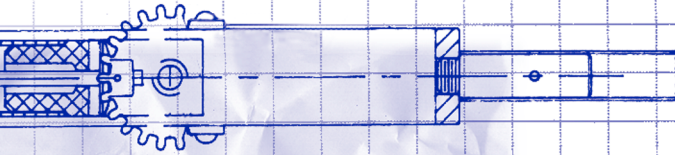

7 8 9

 **ROCHESTER
GAUGES, INC.**

Magnetel® Liquid-Level Gauge Installation Guide

c)

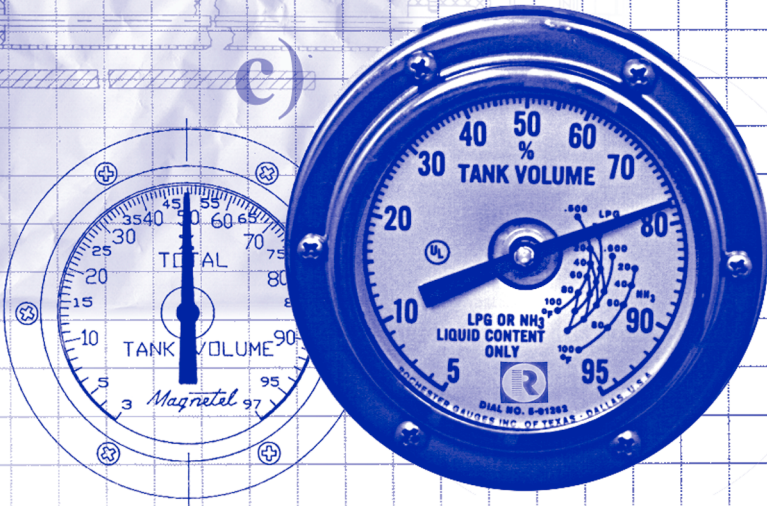

ISO 9001:2008 CERTIFIED

CAUTION*

Read completely before attempting installation. These instructions are prepared to assist qualified personnel familiar with liquid storage tank equipment. Most consumers are not qualified to perform the installation described. If you have any questions about installation or operation of Magnetel® gauges, contact Rochester Gauges or an authorized distributor for assistance.

** Materials and specifications are subject to change without notice.*

Pressure ratings subject to change due to temperature and other environmental considerations.

Construction & Operation

Magnetel® liquid level gauges are designed for centerline mounting or top mounting on bulk-storage tanks, centerline mounting on bobtails or transports. Angle mounting is optional at extra cost.

The materials used in construction are carefully selected for compatibility with the liquid to be gauged, so, you can expect the unit to provide many years of trouble-free service.

Magnetel® gauges are operated by liquid displacement of a float bulb attached to a counter-balanced float arm. The counterbalance has been adjusted so the float will be half-submerged in tank's liquid.

The main gear at the pivot point drives a pinion gear attached to a center shaft. The 2.2:1 gear ratio converts the 140° float arc to 308° of center shaft rotation. A drive magnet, attached to the end of the center shaft under the gauge head, couples with a dial pointer magnet through the solid, non-magnetic head to move a pointer around a dial, usually graduated in percent of tank volume. The limits of measurement are 5% to 95% or 3% to 97% of tank volume.

Attachment To Tank

Different adapters can be welded or screwed into tanks to attach the gauge. Any adapter used must conform to Rochester Machining Standard MS 508 (see page 9). For standard Magnetel® gauges the mounting bolt holes are on the vertical centerline. Straddle mounted gauges for mounting bolt holes spanning vertical centerline are available on special order.

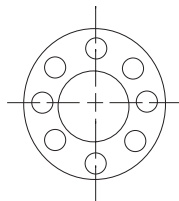

Centerline Mount

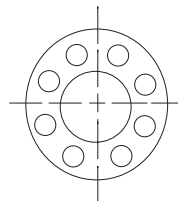

Straddle Mount

The most popular Rochester adapter, 0022-00029, has a 2.5" Male NPT thread which screws into a 2.5" Female NPT coupling welded into the tank. The sealing gasket and eight mounting studs and nuts are included with the Magnetel® gauge. Other adapters are the Rochester 0022-00030 which facilitates close or recessed coupling to the tank head, or the 0022-00500 weld-neck flange which extends a short distance from the tank shell. For full details, ask for the 22 Series Technical data sheet.

The adapter opening diameter the float and counterbalance must pass through is 2.32" diameter. The optional "Y" style gauge goes through a 2" NPT coupling that is a 2.19" opening diameter. A 2" NPT threaded adapter is furnished assembled onto the gauge. Any adapter used must be installed with its axis truly aligned with the tank axis. This enables the installed gauge to be exactly horizontal and provide accurate gauge readings.

Inspection & Assembly Of Gauge

When the Magnetel® gauge is received, remove and inspect it to make sure it is in operating condition. Use the screw and nut or cotter pin provided to install the float arm and dial (per figure 7, step 8) on the gauge. Make sure the float will fall under its own weight by moving the float arm slowly through its range to detect any binding or restriction. The dial pointer should move slightly past the extreme ends of the dial scale when the float arm reaches the limits of its travel.

Make sure it is calibrated properly by aligning the float arm with the support arm. The side or end mounting gauges should then read 50% and top mounting gauges should read below empty. The 50% graduation on the dial should be at the 12 o'clock position after the gauge is installed in the adapter. If you find any problems call Rochester.

Accuracy Precaution

Before installing your Magnetel® gauge, be sure it fits your tank properly. Check the length of the float arm, measuring from the pivot point to the center of the float bulb. This dimension should be .465 times the inside diameter of any horizontal cylindrical tank, and .428 times the inside diameter for mobile tanks with Rough-Rider® gauges.

Before filling the tank, be sure the gauge moves freely inside. Many storage tanks contain dip pipes, baffles, or other obstructions which may interfere with free movement of the gauge float arm, preventing proper performance.

Accurate measurement of Liquefied-Petroleum Gas, LP Gas, or anhydrous ammonia, NH₃, requires converting a volume measured at an observed temperature to the volume at a standard base temperature of 60°F. LP Gas is usually a mixture of propane, butane and possibly other gases, so the conversion factor is usually determined from a chart when the specific gravity of the LP Gas is at 60°F is known.

CAUTION

NEVER EXCEED THE MAXIMUM SAFE FILLING LEVEL.

The temperature chart for various specific gravities (mixtures) of LP Gas is based on the permitted filling densities as given in NFPA Pamphlet 58, Standard for the Storage and Handling of Liquefied Petroleum Gases. This chart is required for an LP Gas liquid-level gauge to be listed under the re-examination service by Underwriters Laboratories, Inc. The chart indicates the maximum safe level for LP Gas when the specific gravity and liquid temperature are known. This safe level allows space in the tank for liquid expansion if the liquid temperature rises.

WARNING

The gauge is not a substitute for a fixed or adjustable liquid level gauge which may be required for filling. Do not use gauge for filling.

WARNING

Failure to follow these instructions or to properly install and maintain this equipment could result in an explosion and/or fire causing property damage or personal injury or death. Rochester Gauges equipment must be installed, operated and maintained in accordance with all federal, state and local codes and Rochester Gauges instructions. The installation in most states must also comply with NFPA standards 58 and 59, and ANSI K61.1.

Only personnel trained in the proper procedures, codes, standards and regulations of the LP-Gas and NH₃ industries should install, maintain and service this equipment.

Be sure all instructions are read and understood before installation, operation and maintenance. These instructions must be passed along to the end user of this product.

Release all system pressure prior to installation. Failure to do so could result in personal injury. Use proper safety equipment at all times. Completely purge the system of all LP-Gas or NH₃.

CAUTION

Contact or inhalation of liquid propane, ammonia and their vapors can cause serious injury or death! NH₃ and LP-Gas must be released outdoors in air currents that will insure dispersion to prevent exposure to people and livestock. LP-Gas must be kept far enough from any open flame or other source of ignition to prevent fire or explosion! LP-Gas is heavier than air and will not disperse or evaporate rapidly if released in still air.

Note

Before installing, inspect float gauge assembly for shipping damage that may affect performance.

Installing The Gauge

If the gauge has not been assembled, read the section on inspecting and assembling the gauge.

1. Place the white plastic centralizers on the short end of the studs for the 4 and 7 o'clock positions with the lips outward and install these studs in the gauge adapter.

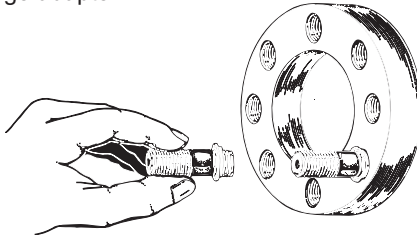

Placement Of 4 & 7 O'Clock Centralizers

2. Place spiral-wound gasket over hole and under centralizers' lips. Never re-use a gasket.

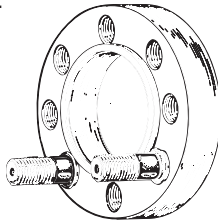

Placement Of Spiral-Wound Gasket

3. Place two more centralizers over studs in the 10 and 2 o'clock positions. Install these and the remaining studs. The gasket is now centered and retained.

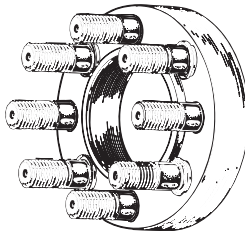

Placement Of 10 & 2 O'Clock Centralizers

Note

Magnete® gauges with -11 & -12 model number suffix are furnished with 0015-00019 gasket.

- Align the float arm with the support and counterbalance mechanism through the adapter into the tank. On side or end mounting gauges, rotate 50% on dial to the 9 o'clock position and insert the gauge float. Slowly rotate the gauge until the 50% graduation on the dial is at the 12 o'clock position (11 o'clock for straddle mount gauges).

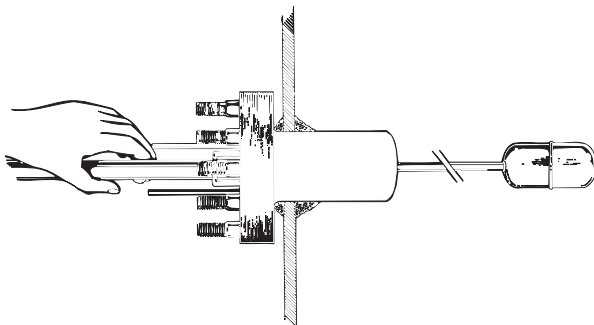

Inserting The Gauge In The Tank

- Slip the gauge head onto studs and start the mounting stud nut at the 6 o'clock position. Remove the dial and install remaining nuts finger-tight. Tighten nuts near the bottom of head just enough to make the head parallel to the adapter face. Tighten in sequence while increasing torque gradually. Make sure the gap between the head and adapter remains the same all the way around. If it is not, loosen nuts near the narrow gap slightly and tighten nuts near the wide gap. After the nuts have been partially tightened and head is parallel with flange, apply about 10 ft.-lbs. torque using nut tightening sequence. Now, apply about 20 ft.-lbs. using nut tightening sequence. Then apply a final torque of 25 to 35 ft.-lbs. to each nut several more times in sequence.

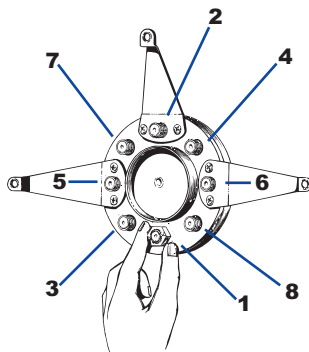

Nut Tightening Sequence

WARNING

Uneven or excessive nut torque can damage gasket and/or gauge head.

6. Installation Inspection

Purge the vessel if necessary. Pressurize it to at least one-third the rated tank pressure if it is a pressure vessel. Check for leakage all around, between head and adapter and around each mounting bolt head. Over-tightening of mounting bolts may cause cracks or warp the head. If no leaks or other defects are detected, fill the vessel. Check for pointer movement after 5% full, prior to filling to the desired level.

7. Dial mounting brackets - 4" model at the 9 and 3 o'clock positions, 8" model at the 9, 12 and 3 o'clock positions.

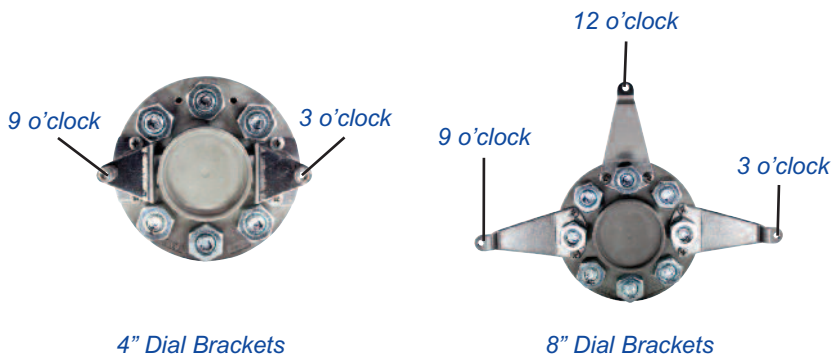

CAUTION

The back of the dial chamber must be seated in the gauge head and all three brackets touching the dial chamber without rocking. If they do not, carefully bend the bracket arms forward until even.

8. Reattach dial chamber - 4" model at the 9 and 3 o'clock position, 8" model at the 9, 12 and 3 o'clock positions.

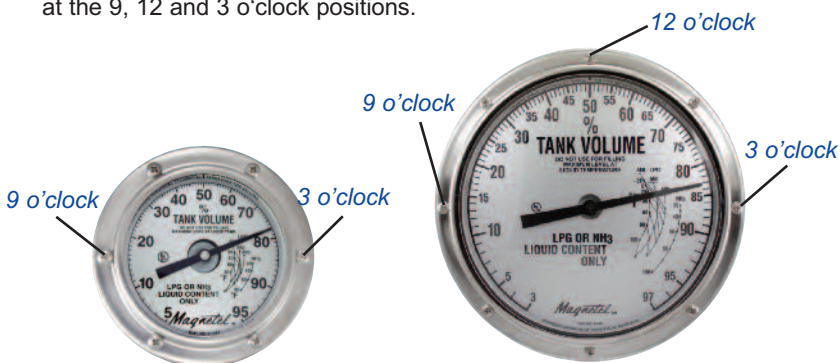

Note

Magnete® dial chamber is factory sealed with dry air to prevent moisture and fogging. Do not remove dial screws, other than shown, as this may break dial seal allowing moist air to enter.

Routine Maintenance And Inspection

- Periodically inspect the portions of the gauge on the outside of the tank
- Replace broken dial glass
- Look for water under the glass
- Replace missing dial and gauge hardware
- Correct any other external physical damage
- Check for leaks and corrosion
- Periodically observe that the dial pointer moves freely in response to changes in tank level

Gas Pressure Warning

In certain isolated cases and with very low temperature, it may be possible to open a tank with slight loss of gas. A 300 lb. pressure gauge may show a zero reading and still have up to four or five pounds pressure in the tank. However, pressure is probably being generated all the time and a sudden pressure reduction will substantially increase the rate of vaporization.

WARNING

DO NOT TEST THE FLOAT FOR LEAKAGE BY ANY MEANS.

If the dial indicates a lower liquid level than what is known, then the gauge float may be leaking and may be filled with liquid. Place the removed float in a safe, isolated and well-ventilated area to give the LP Gas or NH₃ a chance to diffuse. With these liquefied gases and other similar products, a danger of float explosion exists due to liquid or gas expansion resulting from warming a float from any source.

Precautions Regarding Removal Of Gauge

If gauge removal appears necessary, only do so under competent supervision. Make sure tank is completely purged.

Fire Hazard Warning

A hazard of fire or explosion may exist if proper methods are not used, when installing or removing Magnetel® from vessels containing pressurized liquid or gas, flammable liquids, oxidizers, NH₃ or LP Gas.

Removing The Gauge

When removing centerline-mount gauges, do not strain or force the parts, especially in lining up the counterbalance. After mounting stud nuts have been removed, replace the dial chamber and slowly rotate the gauge left or right until the pointer is at the 50% level. In this position, the counterbalance will be parallel to the support arm and can be easily withdrawn through the opening.

With the same careful manipulation, top-mount gauges may be easily removed also. Tip the gauge slightly so the pointer rests at its lowest possible position, slowly withdrawing the gauge from the tank.

Part #	Description
0003-00005	Glass crystal for 8" dial
0003-00022	Tempered glass crystal for 8" dial
0003-00433	Lexan crystal for 8" dial
0003-00001	Glass crystal for 4" dial
0003-00408	Tempered glass crystal for 4" dial
0003-00404	Lexan crystal for 4" dial
0014-00403	Stainless steel centralizer for side-mounting gauges using Buna-N or Teflon gaskets
0015-00010	Gasket under 8" crystal, two required
0015-00451	Channel gasket for 4" crystal
0015-00011*	Mounting flange gasket, Buna-N (LPG)
0015-00856*	Mounting flange gasket, Neoprene (NH ₃)
0015-00019*	Mounting flange gasket – Spiral-wound stainless steel, Teflon-filled
0015-00406	Mounting flange gasket, Teflon
0015S00019**	Gasket kit for side-mounting gauges with spiral-wound stainless steel, Teflon gasket and plastic centralizers
0040-00413	Stainless steel dial screw, #10-32 UNF - 2A
0044-00403	Hex nut, 1/2" - 13 UNC - 2B
0044-00405	Dial nut, #10-32 UNF - 2B
0056-00404	Stud bolt, 1/2" - 13 UNC - 2A
0093S00001	4" Dial chamber mounting bracket
0093-00403	8" Dial chamber mounting bracket
5015S00480	8" Dial chamber, any liquid, 3%-97%
5015S03044	8" Dial chamber, LPG & NH ₃ , 3%-97%
5016S00477	4" Dial chamber, any liquid, 3%-97%
5016S00478	4" Dial chamber, LPG, 3%-97%
5016S00479	4" Dial chamber, NH ₃ , 3%-97%
5037S03047	4" Dial chamber, LPG & NH ₃ , 5%-95%, standard for Rough Rider® gauge
6020S00000	Standard float bulb, 2" dia. x 4-1/4" long
6036S00000	Float bulb and arm assembly for stationary tanks, specify tank diameter
6048S00000***	Float bulb, 2" dia. x 3" long, 800 psi maximum service
6272S00000	Float bulb and arm assembly for -12 series Rough Rider® gauges only, specify tank diameter
6371S00000	Float bulb and arm assembly for all other Rough Rider® gauges, specify tank diameter
0056-00511***	Stud bolt, 1/2" - 13, Stainless Steel, 800 psi maximum service
0044-00529***	Hex nut, 1/2" - 13, Stainless Steel, 800 psi maximum service
***CAUTION - These parts are only intended for use with Magnetel® gauges equipped with stainless steel heads.	

*Use with aluminum flange only.

**Use with stainless steel flange only.

DRAWING NUMBER MS-508

**AN AMERICAN NATIONAL STANDARD
PIPE THREADS, GENERAL PURPOSE (INCH)**

ANSI/ASME B1.20.1-1983

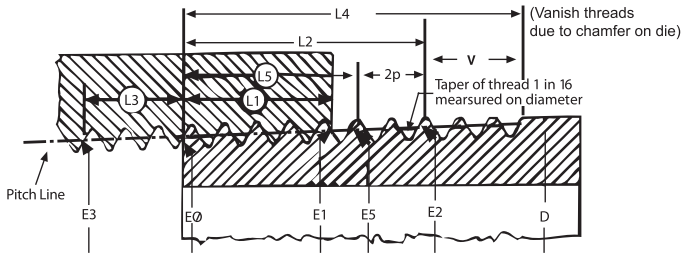

BASIC DIMENSIONS OF AMERICAN NATIONAL STANDARD TAPER PIPE THREAD, NPT¹

Nominal Pipe Thread	O.D. of Pipe (D)	Thread/ in. (n)	Pitch Dia. at Thread (P)	Pitch Dia. at Beginning of External Thread (E0)	Handtight Engagement			Effective Thread, External		
					Length 2 (L1)		Dia. 3 (E1)	Length 4 (L2)		Dia. (E2)
					Inch	Thread		Inch	Thread	
2	2.375	11.5	0.08696	2.26902	0.436	5.01	2.29627	0.7565	8.70	2.31630
2.5	2.875	8	0.12500	2.71953	0.682	5.46	2.76216	1.1375	9.10	2.79062

Nominal Pipe Size	Length, L1 Plane External Thread (L2-L1)		Wrench Makeup Length for Internal Thread 7			Vanish Thread (V)		Overall Length External Thread (L4)	Nominal Complete External Threads		Height of Thread (H)	Increase in Dia./ Thread (0.0625/n)	Basic Minor Dia. at Small End of Pipe (K0)
	Inch	Thread	Length (L3)		Dia. (E3)	Inch	Thread		Length (L5)	Dia. (E5)			
			Inch	Thread									
2	0.3205	3.69	0.2609	3	2.25272	0.3017	3.47	1.0582	0.5826	2.30543	0.06957	0.00543	2.1995
2.5	0.4555	3.64	0.2500	2	2.70391	0.4337	3.47	1.5712	0.8875	2.77500	0.10000	0.00781	2.6195

- Basic dimensions of the American National Standard Taper Pipe Thread are given in inches to 4 or 5 decimal places. While this implies a greater degree of precision than is ordinarily attained, these dimensions are the basis of the gauge dimensions and are so expressed for the purpose of eliminating errors in computations.
- Also length of thin ring gauge and length from gauging notch to small end of plug gauge.
- Also pitch diameter at gauging notch (handtight plane).
- Also length of plug gauge.
- The length L5 from the end of the pipe determines the plane beyond which the thread form is incomplete at the crest. The next 2 threads are complete at the root. At this plane, the cone formed by the crests of the thread intersects the cylinder forming the external surface of the pipe. L5=L2-2p
- Given as information for use in selecting tap drills.
- Military Specification MIL-P-7105 gives the wrench makeup as three threads for sizes 3 & smaller.
- Reference dimension.

NOTE: \odot MOUNT STANDARD, STRADDLE MOUNT REQUIRES SPECIAL GAUGE CONSTRUCTION.

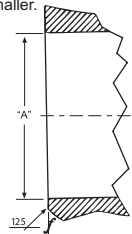
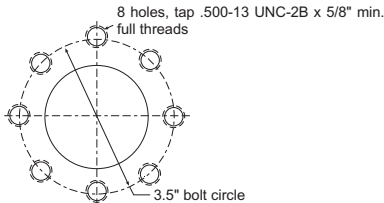

"A" = 2.320" for standard
 "A" = 1.93" for "Y" Magnetel[®] if mounted, it will fit through a 2" pipe coupling but will NOT fit through 2" pipe nipple.
 (All "Y" Magnetel[®] gauges are furnished with a 2" NPT adapter.)

Thread	Dry Torque (ft-lb)
2" NPT	138 (187Nm)
2.5" NPT	146 (198Nm)

Note: Materials and specifications are subject to change without notice.

Pressure ratings subject to change due to temperature and other environmental considerations.

Torque values are given for reference only. Please see line 7 above.

Trouble Shooting

SYMPTOM	LOOK FOR:
<p>Gauge not reading at low extreme when installed in empty tank.</p>	<ul style="list-style-type: none"> • Float striking obstructions such as dip pipes or baffles. • Float or counterbalance striking tank wall. — <i>Incorrect gauge.</i> • Float not dropping under its own weight. — <i>Defective gauge.</i> • Float arm too short for counterbalance.
<p>Gauge continues reading at low extreme when tank is full.</p>	<ul style="list-style-type: none"> • Obstruction on tank bottom. • Float improperly counterbalanced for liquid being gauged. Order correct gauge. • Float leaks and is filled with liquid. — <i>Replace float.</i>
<p>Gauge indicator staying at some midpoint regardless of liquid level.</p>	<ul style="list-style-type: none"> • Float hung not allowing float to follow liquid level — <i>defective gauge.</i> • Float partially sunk due to leakage or improper counterbalancing. — <i>Replace float or gauge.</i> • Dial pointer is stuck due to damage or corrosion. — <i>Replace dial.</i> • Incorrect or modified float arm installed on gauge. — <i>Replace float arm or gauge.</i>
<p>Gauge indicating liquid level inaccurately.</p>	<ul style="list-style-type: none"> • Gauge not fitting tank. Order right gauge. • Gauge mounting adapter not aligned with tank axis. • Tank is not level. • Liquid-temperature volume changes not accounted for.
<p>Gauge face not straight on tank.</p>	<ul style="list-style-type: none"> • Mounting adapter lined up improperly. • Centerline gauge used on straddle mount adapter. • Straddle mount gauge used on centerline adapter.

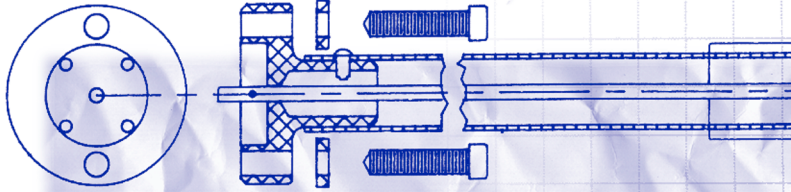

1 2 3 4 5 6

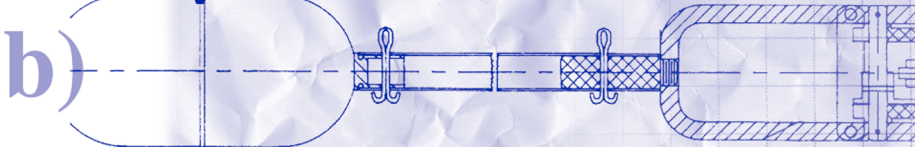
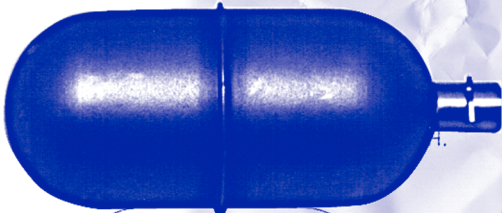

(972) 241-2161 • FAX (972) 620-3374

11616 Harry Hines Blvd. • P.O. Box 29242 • Dallas, TX 75229

Website <http://www.rochestergauges.com> • **E-mail** info@rochestergauges.com

The Measure of Excellence